



RS-485 I/O Acquisition Module

A-1010/A-1012/A-1019/A-1051/A-1055/A-1055S/A-1057/A-1058/A-1060/A-1069

Instruction Manual

- Thank you for purchasing A-10xx Series. We hope you are satisfied with its performance.
- Please read this manual carefully and keep it for future reference.

Warranty

ATC Co. guarantees that this product meets its published specifications at the time of shipment from the factory. Under proper installation it should work as expected. However, ATC Co. can't guarantee that operation in ATC system is absolutely error-free, or without interruption.

Warranty Period

Our products are warranted against defects in material and manufacturing for a period of two years from the date of shipment. During the warranty period, ATC is responsible for necessary repairs as long as the product can be proved to be defective. For warranty service or repair this product must be returned to a service facility designated by ATC. Buyer will pay shipping charges to ATC and ATC will pay return shipping charges.

Excluded Items

This warranty does not include consumptive parts such as batteries, fuses, buttons and relays. Also this warranty does not cover defects caused by improper installation, improper or insufficient maintenance, unauthorized modifications, improper operation, ignorance of environmental specifications, or improper software setting.

Remarks

- *No other warranty is expressed or implied, except for the above mentioned.
- *The remedies provided herein are the buyer's sole and exclusive remedies. ATC shall not be liable for any direct, indirect, special, incidental or consequential damages.

Include Items

Before using this product, confirm that the following items are contained in the package.

- A-10xx product
- This instruction manual
- Accessory rail

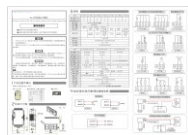

Dimensions

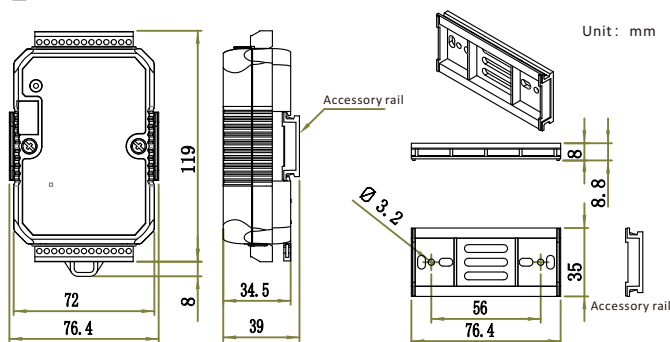

Specifications

Part Number	A-1051	A-1055	A-1055S	A-1060	A-1057	A-1058	A-1069
DI	16	8	8	8	—	—	—
DO	—	8	8	4	12	12	8
DI Type	NPN/PNP(Digital Optical Isolation)						—
DI Isolation	5000VDC						—
DI Logic	Low: <1VDC, High: 5~30VDC						—
DO Type	—	Sink	Source	Relay	Source	Sink	Relay
DO Power	—	10~40V /200mA	10~35V /1A	250VAC /5A or 30VDC /5A	10~35V /1A	10~40V /200mA	250VAC /5A or 30VDC /5A
Protocol	MODBUS RTU + MODBUS ASCII						
Operation Temp	-20 ~ +70°C						
Operation Volt	10~30VDC/24VAC						

Part Number	A-1010/A-1010+	A-1012/A-1012+	A-1019/A-1019+
AI	8(10 Bit)	4(16 Bit)	8(16 Bit)
AO	2(10 Bit)	2(16 Bit)	—
DI	—	2	4
DO	4	2	—
AI Type	0-10V	2*0/4~20mA+2*PT100/1000	0/4~20mA/Thermocouple/Thermistor
AO Type	0-10V	0/4~20mA	—
AI Impedance	Voltage:10MΩ	Current:100Ω, RTD:10MΩ	Current:100Ω, Voltage:10MΩ
AI/O Accuracy	±1%/±1%	±0.1%/±1%	±0.1%/---
Sampling Rate	10Hz (Total)		
DI Logic	Low: <1VDC, High: 5~30VDC		
DO Type	Sink	Source	—
DO Power	10~40VDC/200mA	10~35VDC/1A	—
Interface	1×RS-485		
Protocol	MODBUS RTU + MODBUS ASCII		
Operation Temp	-20 ~ +70°C		
Operation Volt	10~30VDC/24VAC		
Note	A-1010+/A-1012+/A-1019+ are Isolated analog acquisition module		

Wiring Diagrams & Pin Out

Power

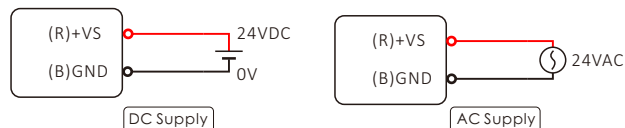

RS-485

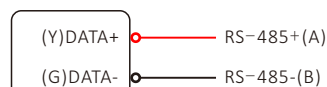

DI support PNP & NPN type

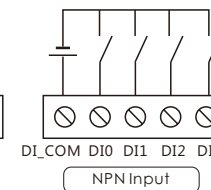
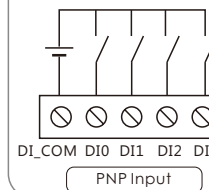

Analog Output

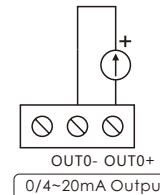

A-1012 PT-100/1000 Input

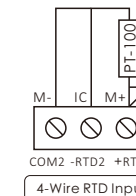
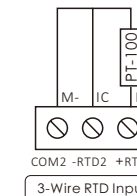
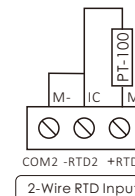

Analog Input

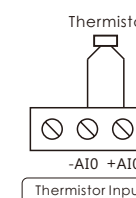
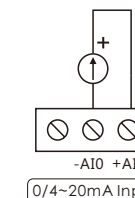

Digital Output

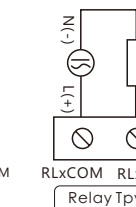
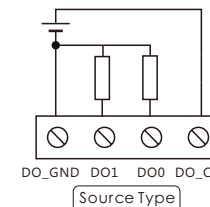
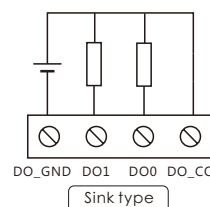

0/4~20mA Sensor connection Wire

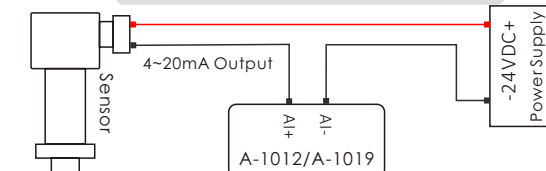

0~10V Sensor connection Wire

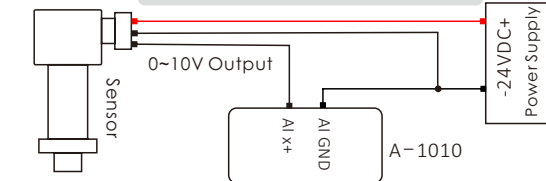

5 Parameter Configuration

Please go to the ATC website to download and install the ATC Utility configuration software.
Website address: www.szatc.com

- Connect the RS-485 communication port between the computer and the module via USB to RS-485 cable, as shown in the following figure.

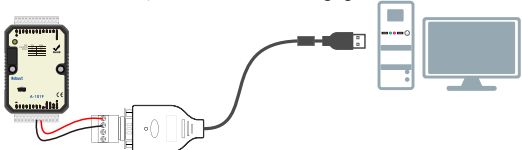

- Before the module is powered on, turn the switch on the back of the module to Init mode.

- Mode description:
Init mode is used to modify parameters in ATC Utility software
Normal mode is the mode used for normal work

- Note:
If the module is in init mode, it cannot communicate with other devices.
The switching mode needs to restart the power supply to take effect.

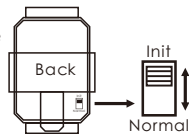

- Click button to refresh COM port. click the COM port which connected the module then click button.

Remarks:
According to the actual connected module model will search for the corresponding model

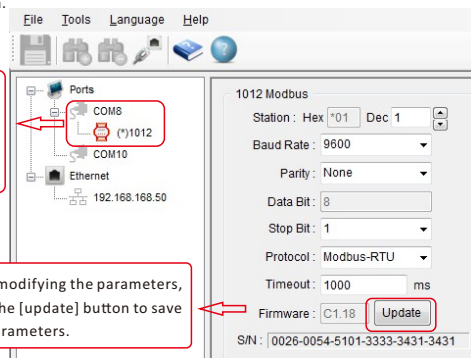

After modifying the parameters, click the [update] button to save the parameters.

- Communication Parameters
Station: Default 1(Dec), The setting range is 1~255.
Serial Parameters: Default 9600 N 8 1.
Protocol: Default MODBUS RTU (MODBUS ASCII Optional)

- System Settings
Comm. Fail Safe: If there is no data communication within the Timeout Settings, the module will automatically perform corresponding actions according to the setting state, such as digital output and analog output corresponding value (setting 0 means disabled)
Power-up Output: You can set the output after Power-up, such as DO and AO.

6 A-1019 Analog Input Type

Thermocouple

(J:-210~760°C) (K:-270~1,370°C) (T:-270~400°C) (E:-270~1,000°C)
(R:0~1,750°C) (S:0~1,750°C) (B:0~1,800°C)

Thermistor

(Thermistor-10K-T2:0~100°C) (Thermistor-10K-T3:0~100°C)
(Thermistor-6.8K:-10~100°C) (Thermistor-4.7K:-10~100°C)
(Thermistor-3.3K:-20~100°C) (Thermistor-3K:-20~100°C)
(Thermistor-2.7K:-20~100°C) (Thermistor-2.252K:-20~100°C)
(Thermistor-2.1K:-30~100°C) (Thermistor-2K:-30~100°C)
(Thermistor-1.5K:-40~100°C) (Thermistor-1K:-40~100°C)

7 A-1019 Jumper Settings

Each AI channel can be independently configured with input type. Before connecting to the sensor, please open the device shell to see CH0-CH7 on the PCB board according to the actual sensor type, and then set the corresponding jumper (channel 0~1 as an example)



Note: if the analog input type setting of the software is inconsistent with the jumper setting on the circuit board, the measured value will be abnormal.

8 Analog Input Type Code Settings

- A-1019 Analog Input Type Code Settings

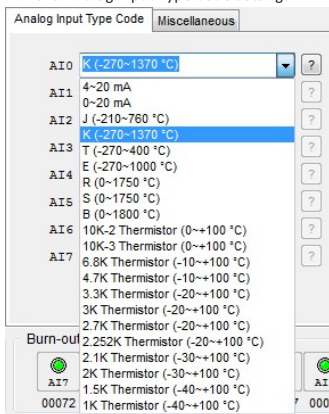

- Set the type of sensor by actually connected. When finished, click [update] to save.

- Click button to check the sensor parameter comparison table.

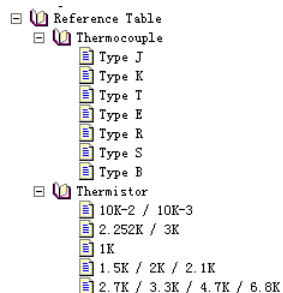

- A-1019 Manual calibration of analog input deviation (miscellaneous)

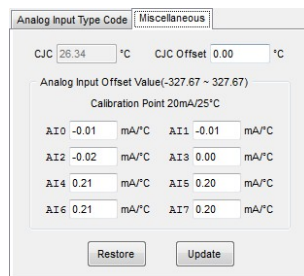

According to the actual measurement deviation, the parameters can be adjusted by manually.

The default parameter environment for factory adjustment is 20mA / 25°C.

After adjustment, click the [update] button to save the parameters.

- A-1012 Analog Input Type Code Settings

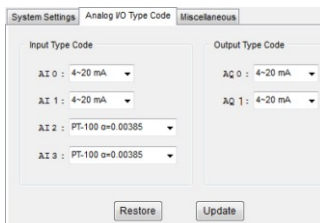

According to the actual application requirements, set the analog input/output range, PT-100/1000 sensor type. Click the [update] button to save the parameters.

9 Modbus Address Mapping

A-1051/A-1055/A-1055S/A-1057/A-1058/A-1060/A-1069

Function Code	01/02/05/15	R/W		-
Address 0x	Item	Normal	Init	Note
00001 ~ 00016	0 ~ 15 DI Input Signal	R	R	
00017 ~ 00032	0 ~ 15 DO Output Value	R/W	R/W	
00033 ~ 00048	0 ~ 15 Power On DO Value	R	R/W	
00049 ~ 00064	0 ~ 15 Communication Fail Safe Value	R	R/W	

A-1012

Function Code	01/02/05/15	R/W		-
Address 0x	Item	Normal	Init	Note
00001 ~ 00002	0 ~ 1 DI Input Signal	R	R	
00017 ~ 00018	0 ~ 1 DO Output Value	R/W	R/W	
00033 ~ 00034	0 ~ 1 Power On DO Value	R	R/W	
00049 ~ 00050	0 ~ 1 Communication Fail Safe Value	R	R/W	
00065 ~ 00066	0 ~ 1 Burn-out Signal	R	R	1:Burn-out
00067 ~ 00068	2 ~ 3 Burn-out Signal	R	R	1:Burn-out
00129 ~ 01152	0 ~ 1023 Auxiliary Memory(M Flag)	R/W	R/W	

Function Code	03/04/06/16	R/W		-
Address 4x	Item	Normal	Init	Note
40001 ~ 40002	0 ~ 1 Current Input Value	R	R	0~20000: 0/4~20mA
40003 ~ 40004	2 ~ 3 Current Input Value	R	R	0~8000: -200~+600°C
40017 ~ 40018	0 ~ 1 Current Output Value	R/W	R/W	0~4000: 0/4~20mA
40033 ~ 40034	0 ~ 1 Power On Analog Output Value	R	R/W	0~4000: 0/4~20mA
40049 ~ 40050	Communication Fail Safe AO Value	R	R/W	0~4000: 0/4~20mA

A-1019

Function Code	01/02/05/15	R/W		-
Address 0x	Item	Normal	Init	Note
00001 ~ 00004	0 ~ 3 DI Input Signal	R	R	
00065 ~ 00072	0 ~ 7 Burn-out Signal	R	R	1:Burn-out
00129 ~ 01152	0 ~ 1023 Auxiliary Memory(M Flag)	R/W	R/W	

Function Code	03/04/06/16	R/W		-
Address 4x	Item	Normal	Init	Note
40001 ~ 40008	0 ~ 7 Current Input Value	R	R	0~20000: 0/4~20mA 0~20700: 0/4~20mA -270~+1800°C
40097 ~ 40104	0 ~ 7 Current Input Value	R	R	0/4~20: 0/4~20mA -270~+1800: -270~+1800°C

A-1010

Function Code	01/02/05/15	R/W		-
Address 0x	Item	Normal	Init	Note
00001 ~ 00008	0 ~ 7 DI Input Signal	R	R	
00017 ~ 00020	0 ~ 3 DO Output Value	R/W	R/W	
00033 ~ 00036	0 ~ 3 Power On DO Value	R	R/W	
00049 ~ 00052	0 ~ 3 Power On Analog Output Value	R	R/W	
00129 ~ 01152	0 ~ 1023 Auxiliary Memory(M Flag)	R/W	R/W	

Function Code	03/04/06/16	R/W		-
Address 4x	Item	Normal	Init	Note
40001 ~ 40008	0 ~ 7 Current Input Value	R	R	0~1000:0~10V
40017 ~ 40018	0 ~ 1 Current Output Value	R/W	R/W	0~1000:0~10V
40033 ~ 40034	0 ~ 1 Power On Analog Output Value	R	R/W	0~1000:0~10V
40049 ~ 40050	Communication Fail Safe AO Value	R	R/W	0~1000:0~10V